

## Before you start

Please check that all components are present and read through these instructions carefully.











## Assembly

1. Check all screws are tight in the ready-made frame sections but avoid over-tightening.
2. Do not yet remove the protective covers on the polycarbonate glazing: note the cover is on the outside of the panels.
3. Assemble the frame body (parts A, B, C1 & C2) using the 35mm bolt (H) and the pre-drilled holes in the frame. (See Fig. 1).
4. Fix the base plates (G) on the underside of two corners as required, using screws (J).
5. Place the lid (D) in position so that the hinges are at the back and are facing downwards. Line up the lid with the frame sides and hold firmly whilst attaching the hinges to the back panel (A) using screws (I). (See Fig. 3).
6. To assemble the lid support arms:
  - a. Pass the washers over the bolts (F) and insert the bolts, from the outside, through the slots in the support arms and into the pre-drilled holes in the sides (C1 & C2). Screw in part way to secure it. (See Fig. 4)
  - b. Tighten the wing bolt when the lid is in the required position.
7. To complete the assembly, peel off the protective sheet from the polycarbonate panels and site the cold frame in good light but out of prolonged fierce sunlight. Use the corner base plates to peg or bolt down the cold frame if extra security is required.

## Care & maintenance

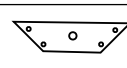
- Extra coatings of wood preservative will prolong the life of the product but be sure to use one that is harmless to plants.
- Avoid constant contact with wet soil by mounting the frame in bricks, slabs or wooden battens.

## Parts & Fittings Supplied

Ref	Description	Illustration	Qty
A	Glazed Back Panel		1
B	Glazed Front Panel		1
C1	Glazed Side Panel Left		1
C2	Glazed Side Panel Right		1
D	Glazed Lid Panel and Hinges		1
E	Lid Support Arms (fitted)		2
F	35mm Wing Bolt 2 and Washer		2
G	Base Plates		2
H	35mm Bolt		8
I	Small Screws		6
J	Base Plate Screws		8

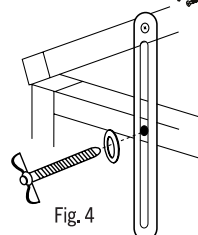
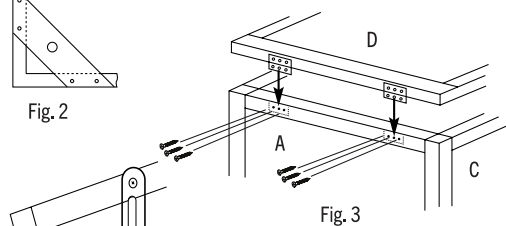
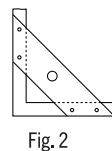
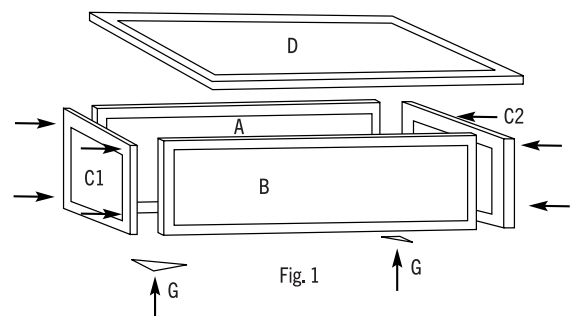

08895

Grow It is a registered trademark of Gardman Crest  
Gardman Crest, Alconbury Hill, Huntingdon PE28 4HY

[www.gardman.co.uk](http://www.gardman.co.uk)