

Arklow Eco

Insert Room Heater Stove



CE

Installation & Operating Instructions

IMPORTANT!

**Our stoves must be fitted by a HETAS/METAC Qualified Installer.
Only Burn Recommended Fuels with this Stove**

Congratulations on the purchase of your New Henley Stove!
With the proper care & attention your Henley stove will give you a lifetime of heat & comfort.
This manual contains instructions on how to install and maintain your Henley Stove.
For both your comfort & safety please take the time to read instructions carefully.



HENLEY STOVES WARRANTY

How to register your new stove:

Henley Stoves does not accept warranty submissions through post/email. Please register your warranty at <https://henleystoves.com/warranty/>

See page 20 of this Manual for full details on **Warranty Terms & Conditions.**

Index

1. Technical Information	3	13. Maintenance	14
2. Stove Commissioning Checklist	4	Baffle Plate.....	14
3. Installation Instructions	5	Door Glass or Rope.....	14
Hearth	6	Fuel Retainer	14
Ventilation	7	14. Air Controls	15
Chimney	7-8	15. Useful Information	15
4. Flue Positions	8	16. Stove Finish (Paint)	16
Height Over Adjacent Building	9	17. Chimney Fire & Over-firing	16
Height Over Roof	9	18. Carbon Monoxide Alarm	16
Height Over Openings.....	9	19. Spare Parts	17
5. Flue Options	10	20. FAQ's	18
Flue Options - Top/Rear.....	10	Annual Service	19
Flue Options - Diagram.....	10	Seasonal Use.....	19
6. Fitting	11	Ventilation.....	19
7. The Clean Air Act 1993	12	21. Terms & Conditions	20
8. Combustible Materials	12		
9. Recommended Fuels	12		
10. Lighting The Stove	13		
Removing the Ash-pan	13		
Refueling.....	13		

Technical Information

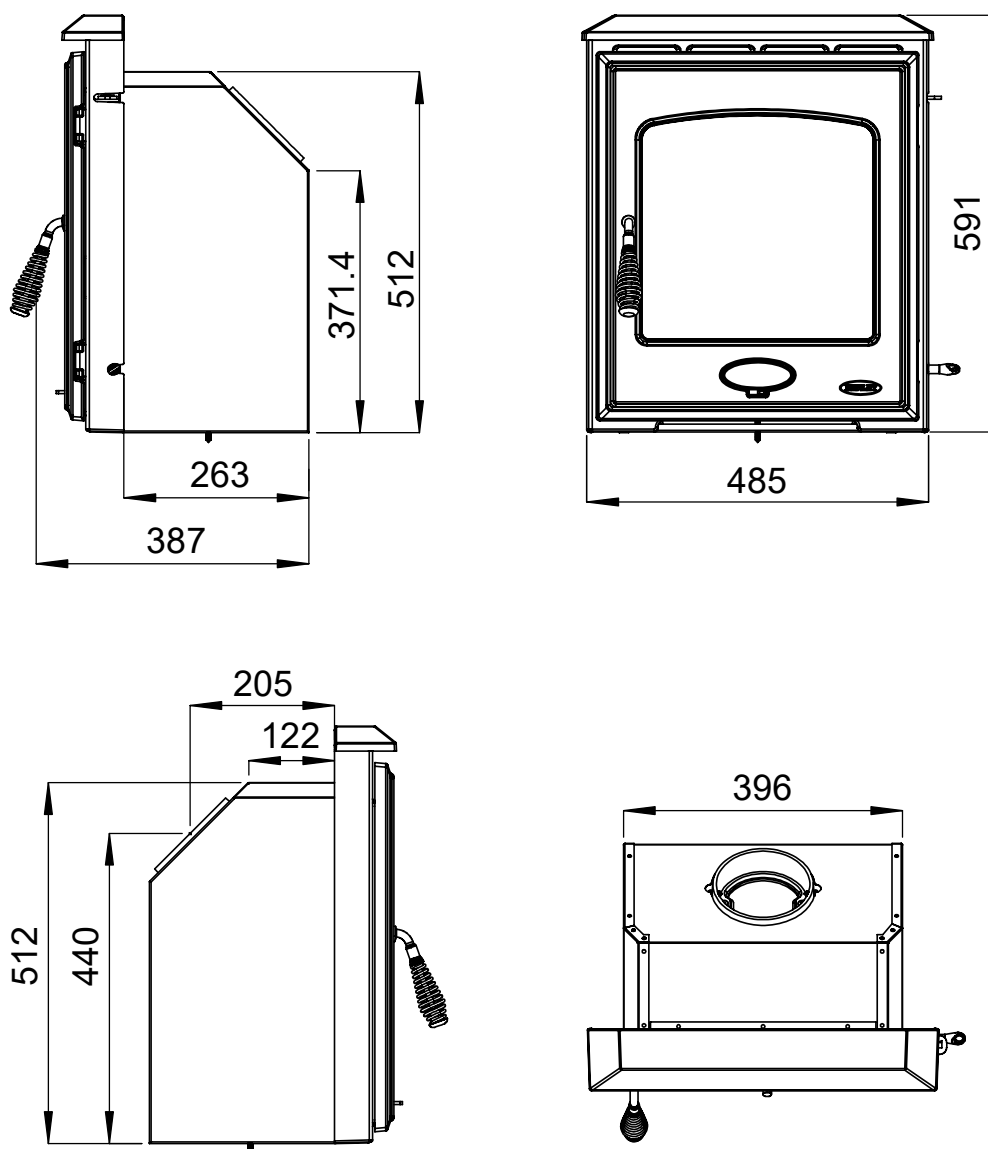

Specifications

Arklow Eco

CONFIRMS TO	EN13229	
WEIGHT	72 KG	
FLUE SIZE	125 mm	
ERP RATING	A	
ENERGY INDEX	107	
FUEL	WOOD	MULTIFUEL
HEAT OUTPUT	4.6kW	4.8kW
EFFICIENCY	79.2%	76.8%
CO AT 13% O ₂ (vol %)	0.08	0.03
NOx AT 13% O ₂ (mg/Nm ³)	102	132
CxHy AT 13% O ₂ (mg/Nm ³)	52	12
EMMISSIONS AT 13% O ₂ (mg/Nm ³)	35	12
FLUE GAS MASS FLOW - g/s	4.6	4.7
MEAN FLUE GAS TEMP. K#	231	286

Stove Commissioning Checklist (for fitters use only)

***Do not send, Please keep this for your own records.** This page should be filled with your fitter on installation of your stove and kept for your reference to help you fill in your online warranty. To fill your online warranty please visit <https://henleystoves.com/warranty/>

Dealer Appliance Was Purchased From

Name: _____

Address: _____

Phone: _____

Essential Information - MUST BE COMPLETED

Date installed: _____

Model Name: _____

Model Description: _____

Serial number: _____

Installation Engineer

Company name: _____

Address: _____

Phone: _____

HETAS/METAC Approved (Please tick relevant box): Yes No If Yes, please include certificate of compliance.

Commissioning Checks (to be completed and signed)

Stove correctly flued according to building regulations: Yes No

Flue swept and integrity of flue verified: Yes No

Smoke test completed on installed stove: Yes No

Spillage test completed: Yes No

Use of appliance and operation of controls explained to end-user: Yes No

Check that specified clearance to combustibles has been adhered to: Yes No

Instruction manual handed to end-user: Yes No

Signature: _____ Print name: _____

Installation Instructions

Installation

Before installation and/or use of this appliance please read these instructions carefully to ensure that all requirements are fully understood. The appliance must be fitted by a registered installer*, or approved by your local building control officer.

Regulations

Please refer to the current issue of **British Standard BS 8303, Code of Practice for Installation of domestic heating appliances burning solid fuel**, Building Regulations, Local Authority Bylaws and other specifications or regulations including Ireland, UK or EU standards referred to as they affect the installation of the stove.

Building regulations available on www.environ.ie & www.planningportal.gov.uk.

Domestic Heating

Only use for domestic heating in accordance with these operating instructions.

Fuel

Only approved fuels must be burned.
Do not use liquid fuels or as an incinerator.

Fireguard

Appliance surfaces become very hot when in use. A fireguard conforming to BS 8423:2010 should be used in the presence of children, the elderly or infirm.

Please note, this appliance should be used with the fire door closed at all times except when fueling, cleaning ash or initial lighting.

Combustible Materials

Do not place photographs, TV's, paintings, porcelain or other combustible items on the wall or near the appliance. Exposure to hot temperatures will cause damage. Do not place furniture, or other items such as drying clothing, closer than 1 metre from the front of this appliance. Do not use aerosol sprays or any other flammable materials near the appliance under fire.

Asbestos

This stove contains no asbestos. If there is a possibility of disturbing asbestos in the course of installation then please seek specialist guidance & use appropriate protective equipment.

Fire Cement

Some types of fire cement are caustic and should not be allowed to come into contact with the skin. In case of skin contact, wash immediately with plenty of water.

Extractor Fan

It is possible to install this appliance in a kitchen or open plan room which uses an extractor fan. Adequate provisions must be made, as the extractor will draw air from the room. A draught test needs to be carried out on the appliance with the extractor fan running on full power. Based on results from the draught test, extra ventilation should be added where necessary.

Ventilation:

Do not obstruct inside or outside ventilation required for the safe use of this appliance.

Alterations

Do not make unauthorized changes to the appliance.

Chimney

The chimney must be swept at least twice a year.

Flue System

Do not connect, or share, the same flue or chimney system with another appliance.

Manual Handling

Before continuing any further with the installation of this appliance please read the following guide to manual handling.

- Always obtain assistance when lifting
- When lifting always keep your back straight
- Avoid twisting at the waist. It is better to reposition your feet.
- Avoid upper body/top heavy bending. Do not lean forwards or sideways
- Always grip with the palms of your hands do not use your fingertips for support, use gloves for a better grip
- Always keep the stove close to the body as this will minimize the cantilever action.

Hearth

Hearths should be constructed from suitably robust materials & to appropriate dimensions. (fig.1)

A way of making provision would be to adopt the guidelines outlined below & to provide a hearth appropriate to the temperatures that the appliance can create around it.

The hearth should be able to accommodate the weight of the appliance & its chimney if the chimney is not independently supported. Consult a structural engineer for advice before proceeding.

If there is no existing fireplace or chimney it is possible to construct a suitable non-combustible housing and hearth setting. The flue must be installed in accordance with all local and national regulations and current rules in force. Check if adding a new chimney to your property requires planning permission.

The Stove should be installed on:

A: Hearths made of non-combustible board / sheet material or tiles at least 12mm thick (fig.3), if the appliance is not to stand in an appliance recess and has been tested to an applicable appliance standard to verify that it cannot cause the temperature of the upper surface of the hearth to exceed 100°C; or

B. Constructional hearths in accordance with the guidelines outlined. (fig.2)
Constructional Hearths should have dimensions as outlined in figure 1 above. They should be made of solid, non-combustible such as concrete or masonry, at least 125mm thick, including the thickness of any non-combustible floor and/or decorative surface.

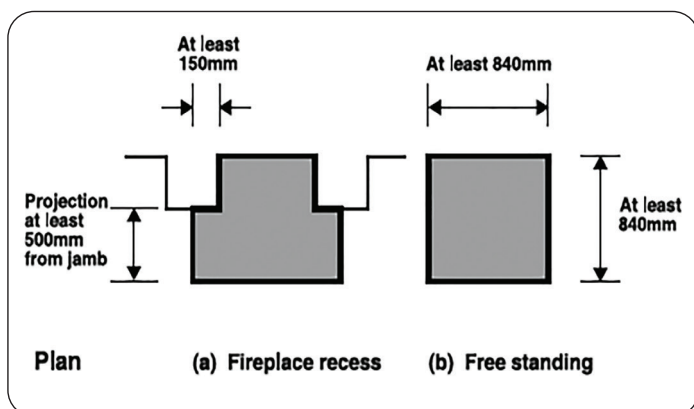

fig.1 Constructional Hearth Dimensions for Solid Fuel Appliances & Open Fires

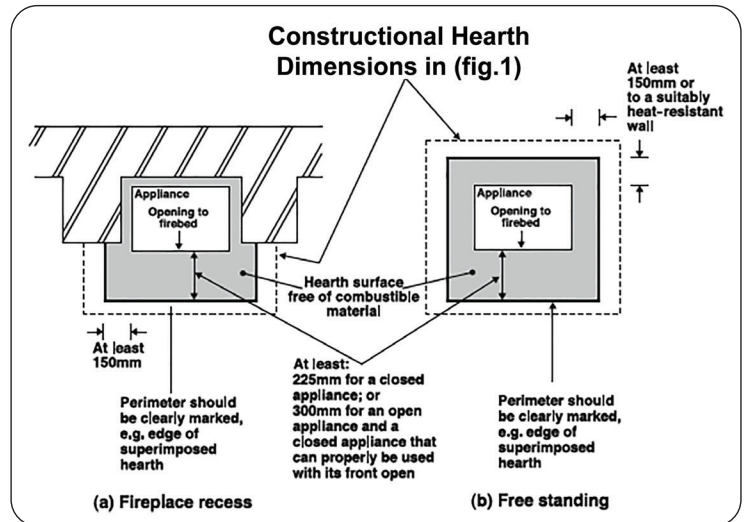

fig.2 Non Combustible Hearth surrounding Solid Fuel Appliance

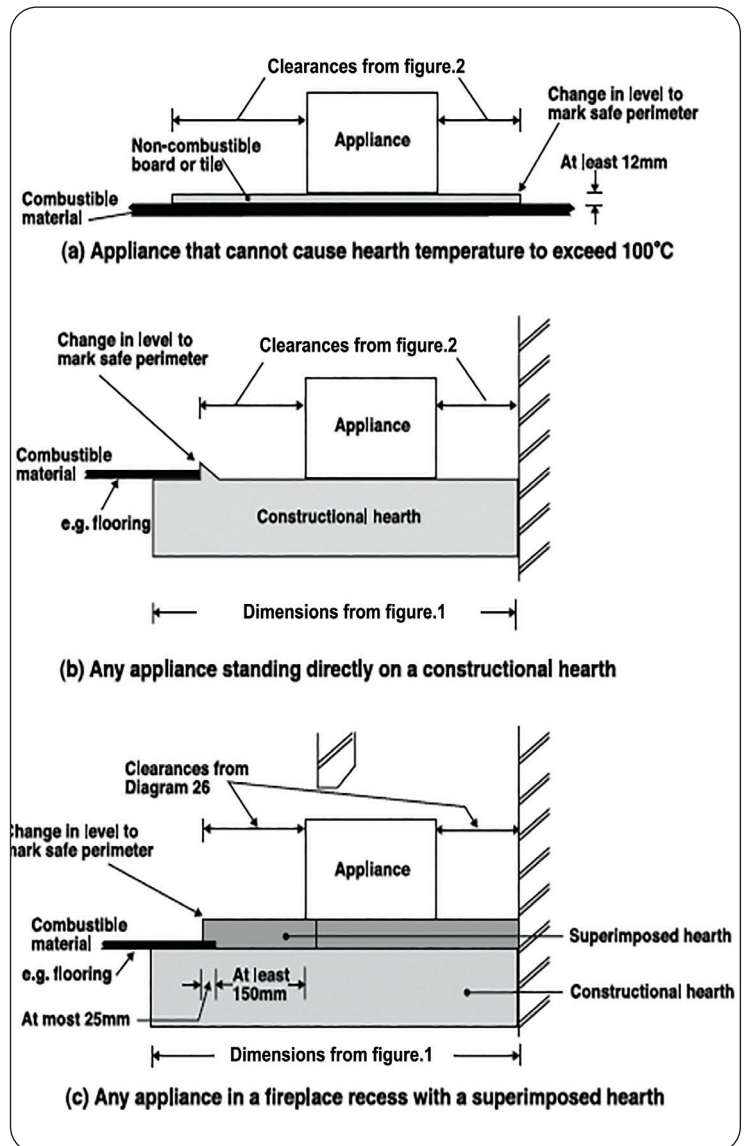

fig.3. Ways of Providing Hearths

Ventilation

This appliance requires a constant supply of air to maintain proper combustion and effective flue performance.

An inadequate air supply can result in poor combustion and smoke entering the room which is potentially dangerous.

This supply of air can come from either:

- The natural leakage of air into the room in which the product is fitted.
- Purpose provided ventilation.

The amount of air required must comply with local building regulations and the rules in force. If spillage is detected during commissioning then there may be insufficient natural ventilation and an additional air supply will be necessary.

Many older buildings are sufficiently ventilated by natural leakage of air to provide suitable air supply for an appliance of 5kW output or less. Any air vents should be positioned so that they are not liable to blockage.

Chimney

Please refer to the current issues of **British Standards BS EN 15287-1:2007 - design, installation and commissioning of chimneys** before commencing installation

The chimney draw is critical on any installation and should be checked to ensure that it matches what is specified. The ideal chimney draught is between 12-15 pascal (Pa) If the draw is higher than recommended, we advise that provision must be made to correct the overdraw. The draw can vary in different weather conditions and the customer should be made aware of this. Failure to correct an over-drawing flue will invalidate the warranty, and may damage the appliance. Please consult a chimney specialist for advice on fitting an anti down draught cowl.

Please remember that chimney draught is dependent on four main factors.

- Flue gas temperature
- Flue height
- Flue size
- Flue terminal

The flue or chimney system must be in good condition.

It must be inspected by a **HETAS** Qualified Installer and passed for use with the appliance before installation. Products of combustion entering the room can cause serious health risks.

The following must be checked:

- The construction of the masonry chimneys, flue block chimneys & connecting flue pipe system must meet requirements of the Building Regulations.

We recommend a flexible flue liner system certified for use with solid fuel systems be used to improve stove performance. The flue liner must be removed when an appliance is replaced, unless proven to be recently installed and in good condition.

If it is necessary to fit a register plate it must conform to the Building Regulations.

- The minimum height of the flue or chimney must be 4.5m from the hearth to the top of the flue, with no horizontal sections & a maximum of 4 bends. Bends must have angles of less than 45 degrees from the vertical.

Ensure the connecting flue pipe is kept a suitable distance from any combustible material and does not form part of the supporting structure of the building.

Make provision to remove the appliance without the need to dismantle the chimney. Any existing flue must be confirmed as suitable for the new intended use as defined in the Building Regulations.

The flue or chimney systems must be inspected and swept to confirm the system is structurally sound and free from obstructions.

If the chimney is believed to have previously served an open fire it must be swept a second time within a month of regular use after installation to clear any soot falls that may have occurred due to difference in combustion levels.

The flue exit from the building must comply with local building control rules. Do not connect to systems containing large voids or spaces over 230mm square.

Chimney

Suitable access must be provided to enable the collection and removal of debris.

The flue must be swept and inspected when the appliance is installed.

The flue draught must be checked with all windows and doors closed and any extraction fans in this, or adjoining rooms, running at maximum speed (see next section for additional ventilation requirements).

- Max. draught = 2.0mm Wg,
- Min. draught = 1.0mm Wg



WARNING

Under no circumstances should this appliance be connected to a shared flue system, that serves any other heating appliance.

Flue Positions

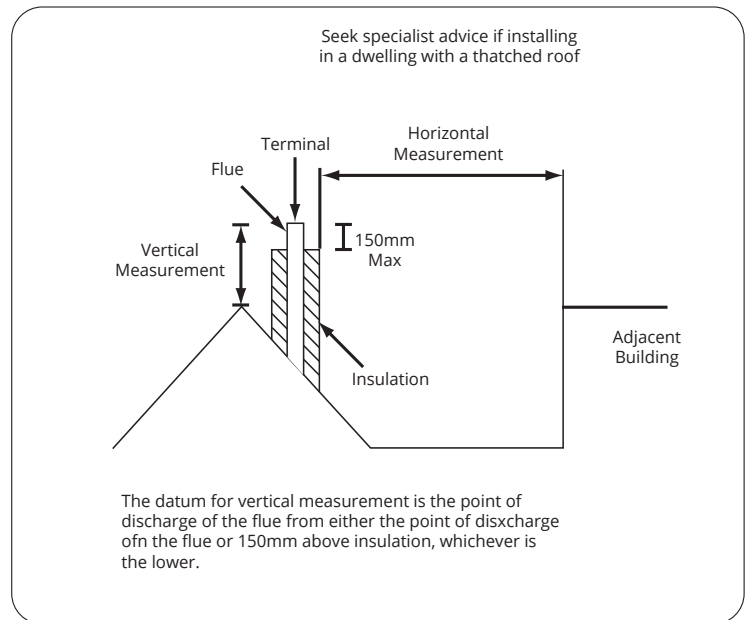
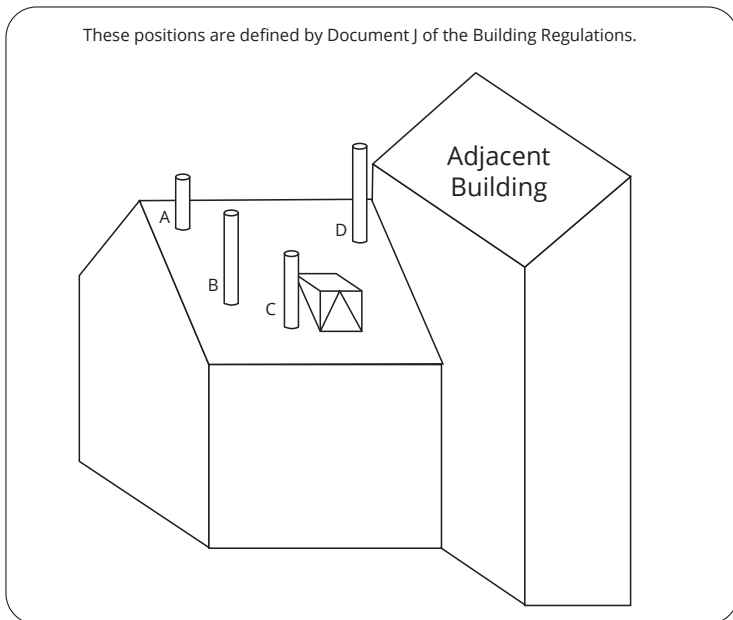

	Point where the flue passes through weather surface (Note 1 & 2)	Clearances to the flue outlet
A	At or within 600mm of the ridge	At least 600mm above ridge
B	Elsewhere on the roof (whether pitched or flat)	At least 2300mm horizontally from the nearest point on the weather surface (a) at least 100mm above the highest point of interaction of the chimney and weather surface; or (b) at least as high as the ridge
C	Below (on a pitched roof) or within 2300mm horizontally to openable rooflight, dormer window, or other opening (Note 3)	At least 1000mm above the top as the ridge
D	Within 2300mm of an adjoining or adjacent building, not beyond the boundary (Note 3)	At least 600mm above any part of the adjacent of the building wall

Note:

1. The weather surface is the building external, such as it's roof tiles or external walls.
2. A flat roof has a pitch less the 10°
3. The clearance given for A or B, as appropriate, will also apply.
4. A vertical flue fixed to an outside wall should be treated as equivalent to an inside flue emerging at the nearest edge of the roof

Height Over Adjacent Building

Note 1

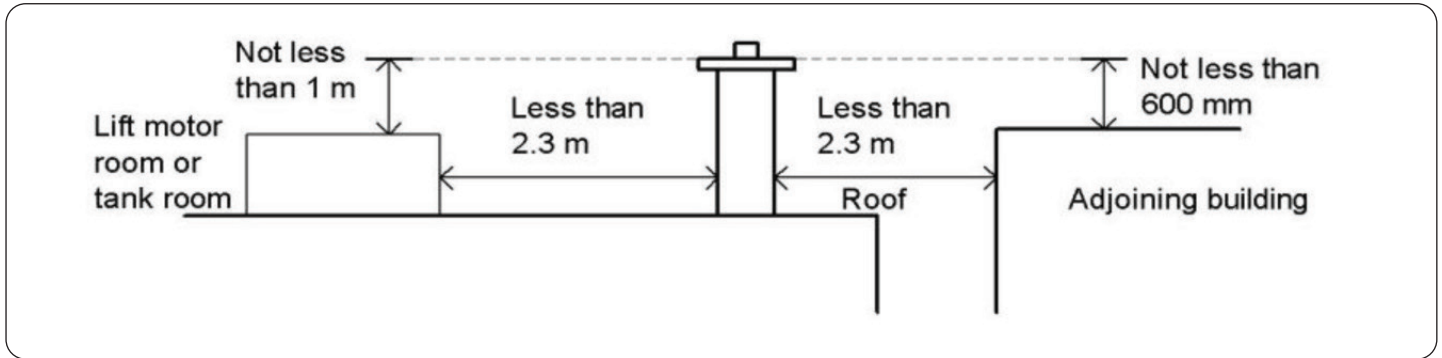

The Outlet of a chimney or flue in relation to an adjacent building should be as seen above

Height Over Roof

Note 2

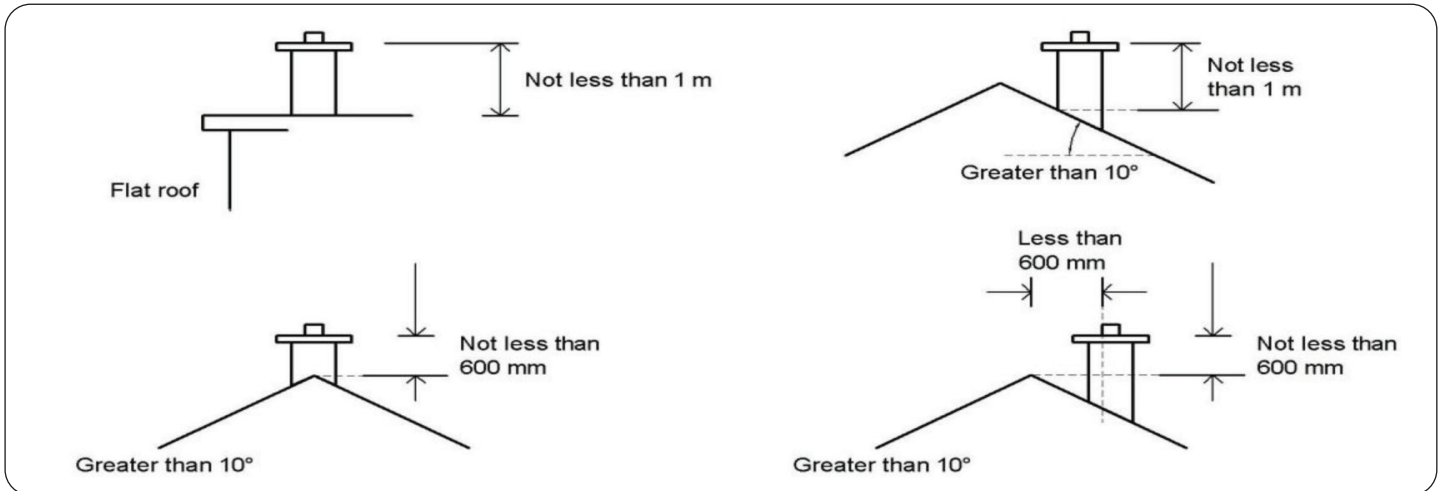

Outlet of a chimney or a flue to be not less that 1m above the highest point of contact of chimney and roof. Where the roof has a pitch of more than 10° on both sides and the outlet is at the ridge or within 600mm of it, the height of the chimney or flue pipe may be reduced to 600mm.

Height Over Openings

Note 3

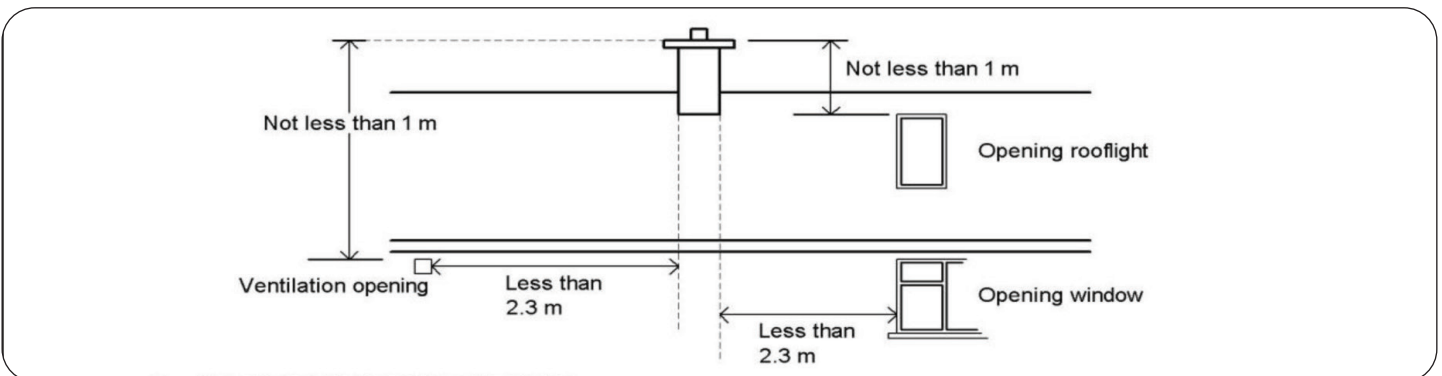

The outlet of a chimney or flue pipe should also be not less than 1m above the top of any opening skylight, opening window or wall ventilator within 2.3m

Flue Options

Each installation is unique to the property so it is not possible to give details to suit every setting.

The installation must comply with Building Regulations and be made using best practice construction methods.

Many fireplace openings have a supporting lintel. Do not remove without supporting the remaining structure of the building.

Do not support the structure with the appliance or the flue system.

Take care when installing the appliance.

Careless handling and use of tools can damage the finish and/or area.



WE RECOMMEND
Flexi-Liner is Used for
Maximum Efficiency The stove
will not perform correctly
without a liner

Flue Options - Rear

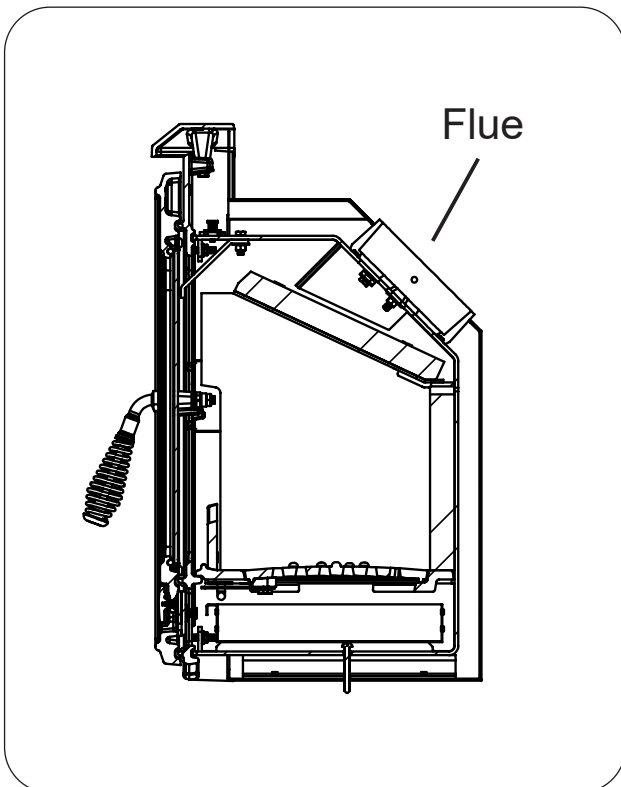

Flue Options - Diagrams

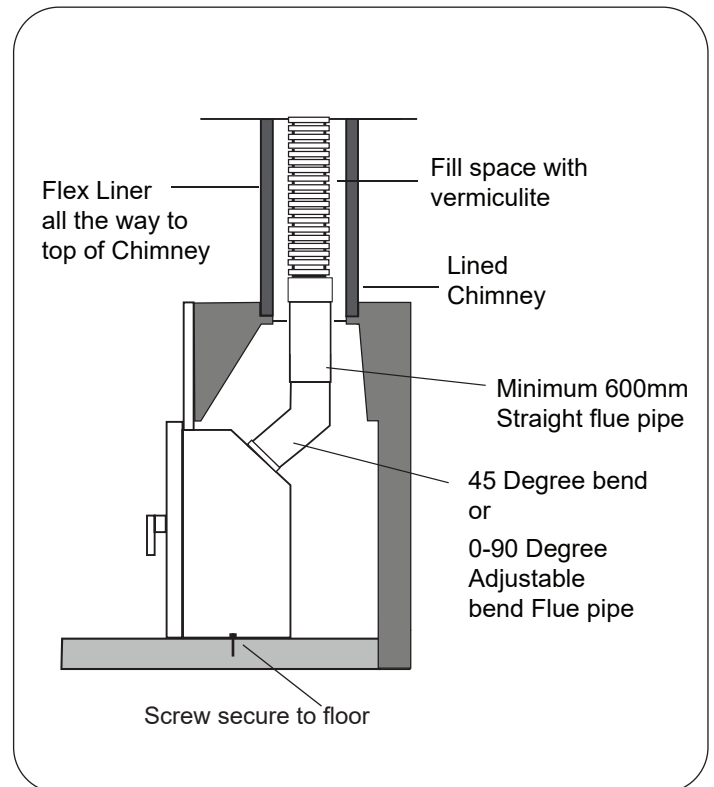

Fitting Instructions

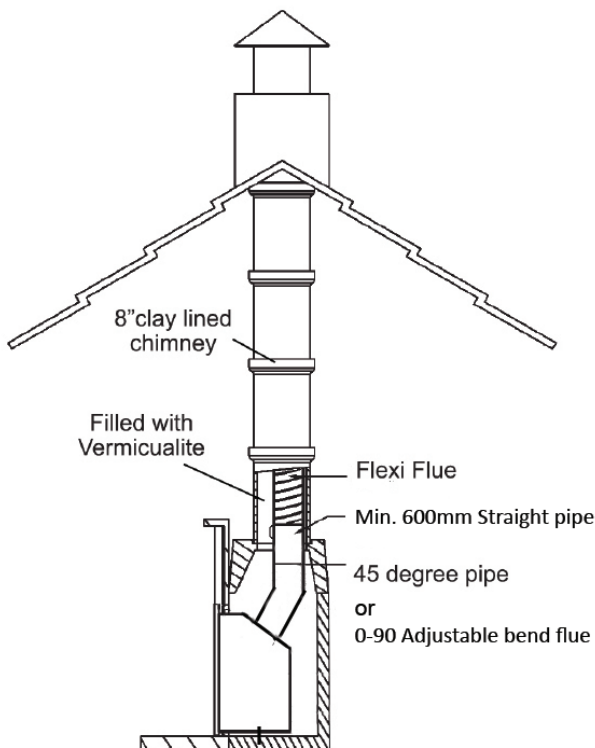
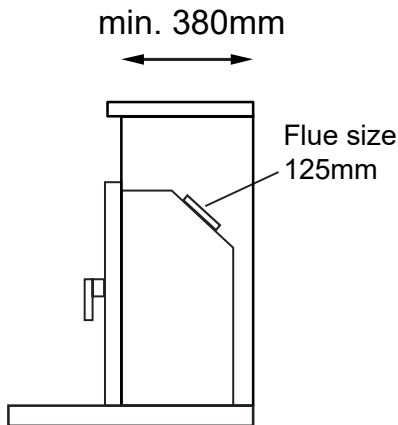
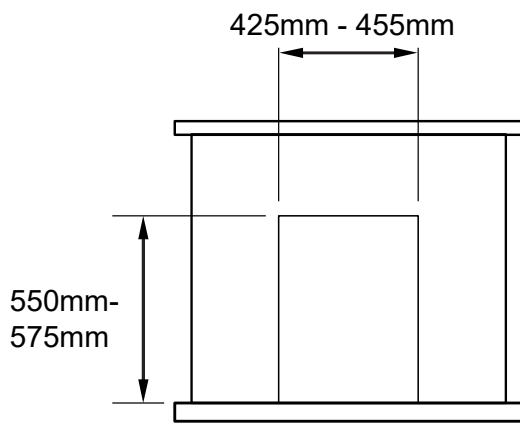

Insulation

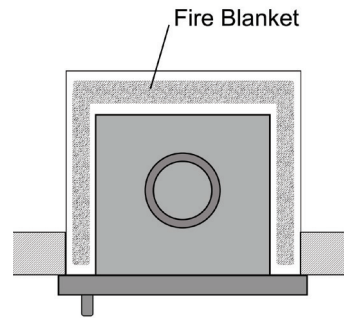

When installing it is recommended to use a fire blanket or heat resistant rock wool

INSTALLATION MUST BE CARRIED OUT BY a HETAS approved fitter in accordance with Building Regulations

Step 1

Prepare the fireplace area, ensuring the opening and recess is suitable for fitting Stove.

Step 2

Ensure both hearth and floor are level, with Stove to be also fitted level and squarely at right angles to hearth.

Step 3

Feed Flexi flue down through the chimney and into fireplace. As required fit adaptor for reducing size from the flexi flue, followed by extension pipes.

Step 4

Carefully install stove to open recess, when fitted squarely mark location for floor screw and drill 5.5mm hole (as image illustrates below), fix stove to the floor using screw.

Step 5

Lay the sealing gasket onto the flue spigot, then fit the flue spigot to the end of the 45 degree adaptor. Fix the 45 degree adaptor to the flue spigot using the grub screws. Then pass the 45 degree adaptor through the flue opening and connect it to the extension pipe.

Step 6

Pull the flue liner back up through the flue outlet until the flue spigot is in position. Fix the flue spigot using bolts. It may be necessary to cut a prop to hold the spigot in place while the fixings are being attached.

Step 7

Complete the installation of the Flexi flue at the top of the chimney in accordance with the Regulations.

The Clean Air Act 1993 & Smoke Control Areas

Under the Clean Air Act local authorities may declare the whole or part of the district of the authority to be a smoke control area.

It is an offence to emit smoke from a chimney of a building, from a furnace or from any fixed boiler if located in a designated smoke control area.

It is also an offence to acquire an “unauthorized fuel” for use within a smoke control area unless it is used in an “exempt” appliance (“exempted” from the controls which generally apply in the smoke control area).

In England appliances are exempted by publication on a list by the Secretary of State in accordance with changes made to sections 20 and 21 of the Clean Air Act 1993 by section 15 of the Deregulation Act 2015.

Similarly in Scotland appliances are exempted by publication on a list by Scottish Ministers under section 50 of the Regulatory Reform (Scotland) Act 2014.

In Northern Ireland appliances are exempted by publication on a list by the Department of Agriculture, Environment and Rural Affairs under Section 16 of the Environmental Better regulation Act (Northern Ireland) 2016.

In Wales appliances are exempted by regulations made by Welsh Ministers.

Further information on the requirements of the Clean Air Act can be found here:

<https://www.gov.uk/smoke-control-area-rules>

Your local authority is responsible for implementing the Clean Air Act 1993 including designation and supervision of smoke control areas and you can contact them for details of Clean Air Act requirements.

Combustible Materials

Safe distances to combustible materials for the **Arklow Eco** should be a minimum of **25cm to the sides, and 110cm to Front of stove.**

The stove should be placed in a non combustible hearth with a distance of **30cm to the top** for wooden mantles (non-combustible mantle top is recommended)

Adjacent walls must be of suitable non-combustible construction, preferably brickwork.

In large fireplaces take care that any supporting beam is protected by a 13mm (0.5”) thick sheet of Masterboard / Supalux spaced 13mm (0.5”) off the surface with strips of non-combustible material.

Make sure that there is a gap between an un-insulated flue system and any combustible material. This gap must be at least 3x the outside diameter of the flue pipe, or 1.5x the flue diameter to non-combustible surfaces.

Recommended Fuels

Wood logs

- Burn only seasoned timber with a moisture content of less than 20%. To ensure this allow cut wood to dry for 12 to 18 months.

Poor quality timber causes low combustion efficiency, produces harmful condensation, reduces effectiveness of the airwash and life of the appliance.

DO NOT burn construction timber painted, impregnated / treated wood, manufactured board products or pallet wood.

Wood length max 200mm, and 100mm in diameter.

Solid Fuel

- Burn only anthracite or manufactured briquette smokeless fuels listed as suitable for use with closed heating appliances.

Lighting the Stove

We recommend that you have two or three small fires before you operate your stove to its maximum heat output.

This is to allow the paint to cure in steadily and to give a long service life of the paint finish. During this curing in process you may notice an unpleasant smell whilst the finishes finally cure. It is non-toxic, but for your comfort we would suggest that during this period you leave all doors and windows open.

First, open the primary and secondary air wash control fully. Load the firebox with plenty of starting fuel, i.e. paper, dry sticks and/or firelighters.

Light the fire at the base leaving the primary and secondary air control fully open. Leave the door slightly ajar for 10 minutes to enhance initial starting and reduce smoke emission – **DO NOT leave the stove unattended if the door is left ajar.**

Allow the fuel to reach a steady glow and build the fire up gradually by adding a few small sticks or well split logs at a time. Once you have a good fire bed established across the grate, further fuel can be added step by step as required.

Don't be tempted to overload the fire bed with fuel all at once or close down the air controls too much until the fire is really well established for some time.

Once the ignition period is well under way close the primary air and gradually reduce the secondary air wash control opening to establish the burning intensity you require (usually open 25% approx.).

Maintenance: Removing the Ashpan

The ash pan should be emptied at least twice a day or when the ash reaches the top of the ash pan.

Ash may be removed with a small metal shovel whilst the fire is still alight, by raking the embers of a low fire to one side of the firebox and carefully removing the ash. Repeating the procedure for the other side of the firebox. Care must be taken not to risk burning your hands or household objects from falling embers.

Refueling the Stove

When burning wood, the fire will die down as the fuel is consumed. When the flames disappear and the remainder is breaking down into glowing embers it is an appropriate time to consider re-fuelling.

Note: If the flames disappear and there are still lumps of solid wood left this indicates excessive moisture in the wood or insufficient air supply/ flue draught.

Note: To eliminate unwanted smoke emission, after loading new logs on to the fire, open the air wash control up fully for 1-2 minutes to boost the fire and get flames issuing from the top of the fuel as soon as possible. When flames are well established, reduce the air wash to the running setting required.

Burning without flames above the fuel will create unnecessary smoke.

DO NOT load fuel above the tertiary air inlet holes at the back of the firebox.

Loading 1 to 2 medium sized logs will produce a good output with reasonable burn time, generally small logs will burn up quicker producing a high output for a short time and a large log will take longer to burn and produce less output over a given time.

This appliance is approved for intermittent operation on wood (0.75 to 1.5 hour burn cycles) although much longer burn times can be achieved by fully loading the firebox, getting the fuel burning well and then shutting the air controls down.

The fire will then often need reviving by first dashing and then using small pieces of wood and plenty of air to get flames issuing from the wood again.



WARNING

HENLEY RECOMMENDS THAT WOOD LOGS BE PLACED VERTICALLY IN THE STOVE FOR BEST FLAME & FUEL CONSUMPTION RESULTS

Maintenance: Replacing Baffle Plate

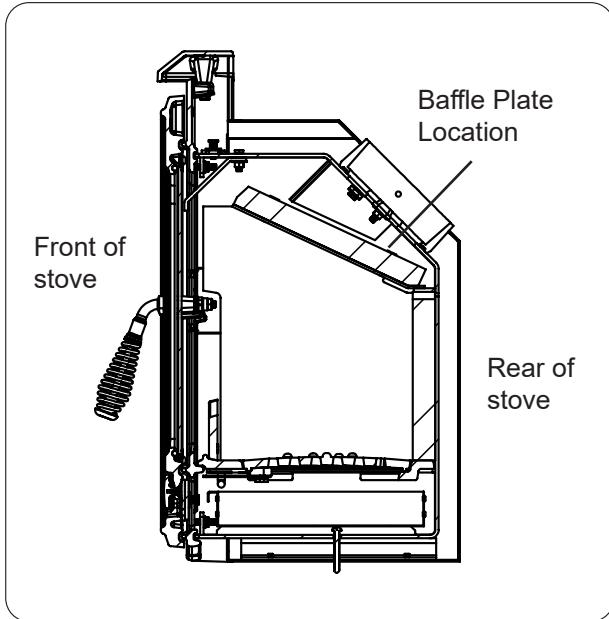

Baffle Plate Location

Replacing Door Glass or Rope

In the event of the door glass being broken it can easily be replaced using the following procedure:

- Ensure the appliance is cold
- *Optional (can be done without taking door off as some stove doors are difficult to remove) Unscrew the hinges / loosen the bolts and lift the door off the appliance and lay onto a flat surface with the rear face upwards (*This is optional and can be done without taking the door off the stove)
- Carefully remove the old rope gasket and old adhesive.
- Take note of the layout of the rope seal. Ensure no traces of the old adhesive or rust / flaky paint is present, as this will result in an unsound joint.
- Apply the rope adhesive following the instructions on the bottle
- Press the rope gasketing into the channel on the rear door casting, following the same layout as the old rope seal.
- Just before the final end, cut the rope seal to length and glue into position.
- Allow at least 30 minutes before refitting the door to the appliance.



Stove Door Glass

Maintenance: Replacing Fuel Retainer

Lift fuel retainer clear of the supporting brackets.

Pull directly up to clear the sides of the door opening.

Do not use appliance without the fuel retainer in position.

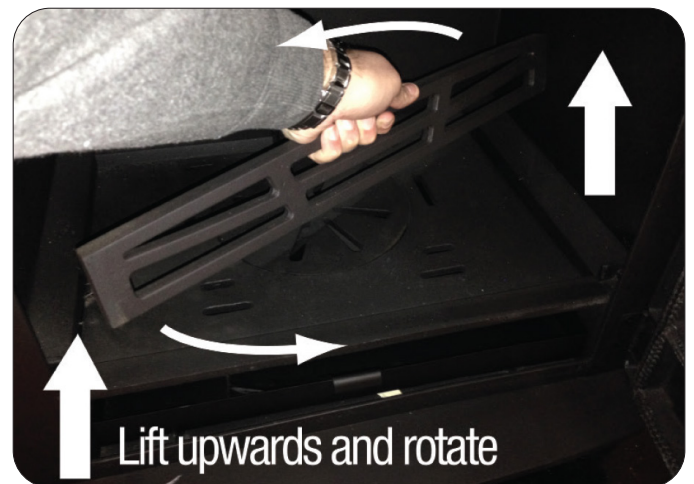

DO NOT LEAVE AIR LEVERS / RODS FULLY OPENED FOR LONG PERIODS.
We Recommend to Never Open More than 60%,
As Extended Use of Stove at More than 60% Proficiency May Damage Stove.

Air Controls

Henley Stoves appliances have air systems providing cleaner burning, and greater efficiency and control. Please see diagram to view where the various air controls are located on your Henley Stove

1) Primary Air - lever is on the stove door controls the primary air and allows air into the stove. You would normally push this when starting a fire to allow air into the stove for maximum combustion (please see below image)

2) Secondary Air (Airwash) - lever is on the upper right side of the stove. This allows a film of air to pass over the glass which in turn keeps the glass clean. Please note the glass may become visibly darker when the stove is cold. (please see below image)

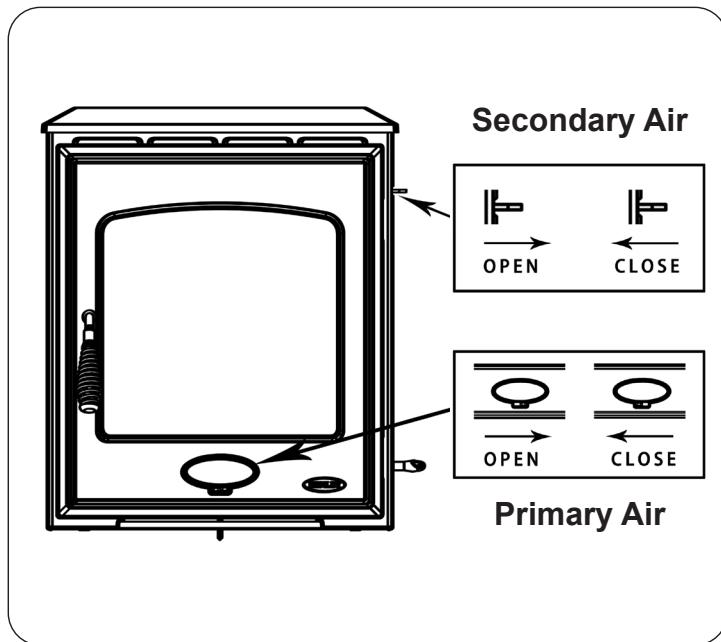

Stove Air Controls



DO NOT USE YOUR BARE HANDS

Stove Parts become very hot while the stove is running so should not be touched with bare hands. Special operating tools and or a glove are provided for operation of the hot stove.

Useful Information

Properly installed, operated and maintained, this appliance will not emit fumes into the room.

Occasional fumes from de-ashing and refuelling may occur.

Persistent fume emission is potentially dangerous and must not be tolerated.

If fume emission does persist:

- Open doors and windows to ventilate the room.
- Leave the room.
- Allow fire to burn out and safely dispose of fuel from the appliance.
- Check for chimney blockage and clean if required.
- Do not attempt to relight until the cause of the emission has been identified and corrected
- If necessary seek expert advice.
- All open flued appliances can be affected by temporary atmospheric conditions which may allow fumes to enter the house.
- Because of this an electronic carbon monoxide detector conforming to the latest edition of BSEN50291 must be fitted in the same room as the appliance.
- The existence of an alarm must not be considered a substitute for ensuring regular servicing and maintenance of the appliance and chimney system.
- If the alarm sounds follow the instructions given under Warning above.

Stove Finish (Paint)

The outside of the stove is finished in a durable high temperature paint.

It is best cleaned by brushing down with a soft brush.

Do not allow water to remain on the surface where cold or rust may occur.

The high temperature paint finish should not require attention for some time, depending on use.

The hotter the fire is burned, the sooner repainting will be necessary.

Aerosol tins of paint are available for complete refurbishing from Henley Stoves.

Repainting Instructions:

- Make sure the stove is out and cold
- Remove door glass
- Lightly brush the body of the stove with a wire brush & rub down with wire wool. This will remove any loose paint powder.
- Mask or remove items such as brass work.
- Adjacent brickwork, mantelpiece, hearth etc., should be carefully masked for quite a distance around the appliance. (this precaution is to prevent the discoloration of the surrounding brickwork, wallpaper etc).
- Re-spray in a well ventilated area, avoid breathing the vapor. Refer to the safety instructions on the paint can.
- When paint is dry refit door glass and any other parts previously removed.
- Leave to dry for 8 hours and refit the door glass etc.
- Burn slowly for the first 4 hours, then build up heat gradually to cure the paint.



USE ONLY GENUINE

HENLEY STOVES SPRAY PAINT

as some paints interact and spoil the stove finish & will invalidate the warranty.

Chimney Fire & Over-firing

DO NOT OVER FIRE YOUR APPLIANCE.

Over firing your stove will cause the paint to peel off your stove and is not covered in our warranty.

Using any flammable liquids, or too much fuel, or firing the stove at maximum for prolonged periods may result in over firing.

If the chimney connector or casing starts to glow red, the appliance is being over-fired.

This may result in a chimney fire.

If a Chimney Fire Occurs :

- **Call the Fire Service - Dial 999 or 112**
- **Immediately close all of the air inlets to the appliance to reduce the air supply to the fire.**
- **Move items of furniture and combustibles away from the stove to reduce the risk of a fire, and allow access for the fire service.**
- **Ensure access to the loft space is available**
- **Evacuate the property**

NOTE: The Chimney fire may have caused structural damage to the chimney.

Do not use the stove again until the stove, chimney and connector have been inspected, and any damage parts have been repaired or replaced.

This work should only be carried out by a **HETAS registered engineer.**

Carbon Monoxide Alarm

As part of act **SI.9 and TGD Part L (2014)** it is now mandatory to install a Carbon monoxide detectors in any dwelling with combustion and discharge of combustion gases from heat producing appliances“

Spare Parts

Over time you may require replacement parts for your Henley Stove.
Replacement parts are available through your local stockist.

OR GO TO WWW.HENLEYSTOVEPARTS.COM AND ORDER ONLINE.

ONLY USE GENUINE HENLEY APPROVED REPLACEMENT PARTS FOR YOUR STOVE.

Please register your warranty at <https://henleystoves.com/warranty/>

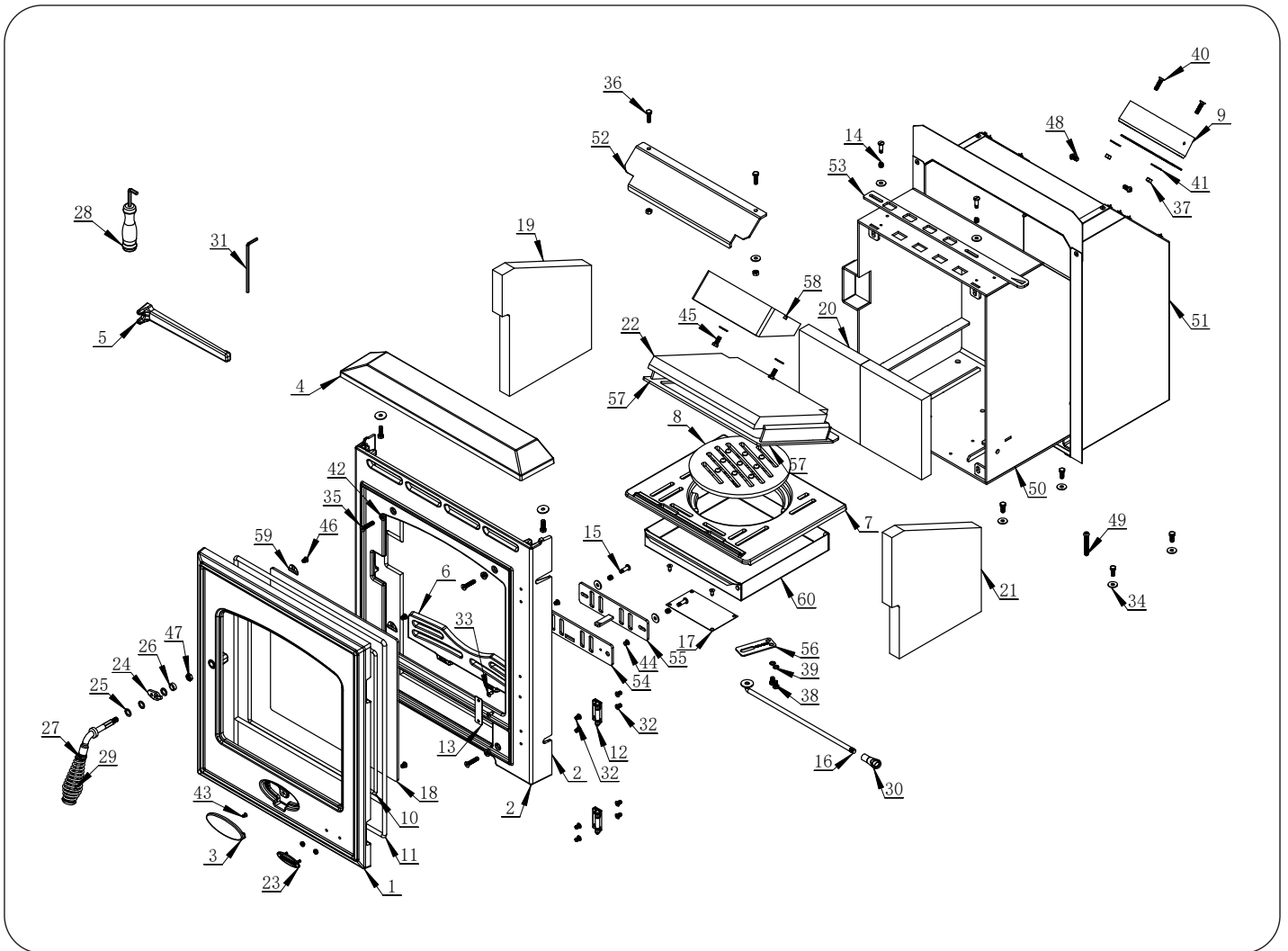

Frequently Asked Questions (FAQ's)

Why are my air inlets puffing smoke?

Combustion gases can build up in the firebox and ignite as small explosions, causing smoke to puff out of the air inlets and other openings. This occurs if the air controls are shut soon after adding new fuel to a very hot fire. Stop by opening the air controls to increase combustion air and burning rate.

What is a flue draught?

The chimney has two main functions:

- 1)** To safely remove the smoke, gases and fumes from the house.
- 2)** To provide a sufficient amount of draught (suction) in the appliance ensuring the fire keeps burning.

Draught is caused by the rising hot air in the chimney when the appliance is lit.

Symptoms of poor performance related to flue draught include:

- Excessive fuel consumption (high flue draught).
- Poor burning control and/or overheating (high flue draught).
- Wind noise from air controls (high flue draught).
- Difficulty getting a fire going and keeping it burning well (low flue draught).
- Low heat output (low flue draught).
- Smoke entering room when doors are opened (low flue draught).
- The construction, position, size and height of the chimney all affect the performance of the flue draught.
- Other factors effecting the flue draught include nearby trees or buildings causing turbulence.
- We suggest installing a chimney cowl or anti-downdraught cowl if you are experiencing issues with draught in your chimney.
- Please note issues with flue draught is out of the control of Henley Stoves and does not warrant a service call.
- We recommend you contact a chimney specialist if the addition of a cowl does not resolve a flue draught issue.

Why is there no heat from my stove?

- 1)** If your stove is installed in an alcove, you need to cap off the area directly above the stove by installing a 3mm mild steel plinth with insulation to prevent the heat from escaping.
- 2)** If the fire continues to consume large amounts of fuel you may need to check the baffle plate is fitted correctly and also if there is too much of a draw up the chimney.
- 3)** A simple test would be to open the door of the stove when it is not lighting and listen to see if you can hear wind in the chimney. If so this means you will need to install a damper in the flue to prevent the up draught. We recommend you contact a piping specialist and install an anti-up draught cowl.

I'm finding it very hard to light a fire in my stove? Why is this?

- 1)** In some houses there may not be sufficient ventilation in the room for the fire to light effectively. You may need an additional air vent in the room to use the stove efficiently.

There is smoke coming out of the stove when I light it, why is this?

- 1)** To ensure maximum efficiency and to prevent the stove from smoking, the pipe at the back to the stove must be max 150mm before the 45 degree bend in the pipe, otherwise the smoke will not be able to escape up the chimney.
- 2)** Stoves that are installed in flat roof houses or extensions may have this issue due to the structure of the building.

It may also be because the chimney of your house is lower than the highest point of your roof which causes the wind to funnel down the chimney.

We recommend you install a rotary cowl to resolve the issue. We recommend you get your stove installed by a professional.

Why is the glass on the door of my stove dirty?

- 1)** Simply open the airwash and pull the lever to the open position and open the primary. The airwash is normally located above the door of the stove. The glass will become visibly clean. Please note the glass will become visibly dirty when the fire stops.

My grate has already burned out, why is this?

1) Not cleaning the grate after every fire will result in the grate burning out prematurely.

How often should I clean my chimney?

1) The chimney and the connecting flue pipe must be swept at least twice a year. Ensure you remove any deposits from the oscillating grates, the firebox surfaces and the flue collar.

Annual Service

Before the start of the heating season strip, inspect and clean the appliance using the following instructions:

- Allow appliance to cool.
- Remove all internal parts: baffle, log guard and firebricks.
- Take care handling firebricks as they can become fragile after a period of use.
- Sweep the appliance at this point if necessary.
- Vacuum clean any remaining ash and debris from the inside of the appliance.
- Check the parts for any damage.
- Replace any damaged parts using genuine Henley Stoves replacements parts.
- Check and clean the firebricks with a soft brush.
- Some surface damage will occur during use. The life of the bricks will depend on the type of fuels burnt and the level of use.
- Replace damaged bricks as soon as possible.
- Re-fit cleaned internal parts.
- On printed glass surfaces, use Glass Cleaner. Do not use abrasive cleaners to remove tar or soot deposits from the glass.
- Fit new door rope seal
- Lightly oil the door catch mechanism and hinge pins. Avoid getting oil onto the door seals and glass.

Seasonal Use

Remove the baffle and inspect the inside of the stove and the flue ways and ensure they are 100% clear after a period of disuse, for example if the stove is not used during the warmer periods of the year.

Also set the air controls half open to keep the appliance ventilated and stop the build-up of any moisture inside.

Note:

We recommend you open the stove door once a month to ensure it does not seize and get affected by moisture build-up.

Ventilation

According to

Building Regulations 2014 for Heat Producing Appliances,

Any room or space containing an appliance should have a ventilation opening (or openings) of at least the size shown below

For appliances designed to burn a range of different solid fuels the air supply should be designed to accommodate burning the fuel that produces the highest heating output.

Air Supply to Non-Room Sealed Solid Fuel Appliances

Open Flue Solid Fuel Appliances should have a permanent ventilation opening of free area of at least:

- 6,500 mm² where air permeability is greater than 5.0 m³/(hr.m²), or
- 6,500 mm² + 550 mm² per kW of rated output above 5 kW where air permeability is less than 5.0 m³/(hr.m²).

Note:

It is unlikely that dwellings built prior to 2008 would have an air permeability of less than 5m³/(hr.m²), at 50 Pa unless extensive air tightness measures have been carried out

HENLEY STOVES TERMS & CONDITIONS

You need to register your warranty online at. <https://henleystoves.com/warranty/>
Failing to register your stove will only give you standard Henley Warranty.

Warranty Terms & Conditions

Room Heater Stoves – 5 Year Warranty *(on main body of stove)

- 1 year standard manufacturers warranty as in accordance with EU regulations.
- 4 year extended Henley warranty will be added if stove warranty is registered online within first 3 months of purchase of your new Henley room heater stove.

Boiler Stoves – 3 Year Warranty on Boiler

- 1 year standard manufacturers warranty as in accordance with EU regulations.
- 2 year extended Henley warranty will be added if stove warranty is registered online within first 3 months of purchase of your new Henley room heater stove.

Stove Fitting / Installation

- The appliance must be installed by a HETAS / METAC approved fitter in accordance with Building Regulations in order for the warranty to be valid.
- If upon opening the stove, it is found to be damaged in any way, do not attempt to install the stove. Return to retailer where it was purchased from.
- Please ensure that the appliance is the correct size (kW) to effectively heat the room where it is to be installed to avoid poor performance issues.

Warranty Limitations

- Grates and baffle plates are guaranteed for 1 year.
- There is no guarantee on glass and fire bricks.
- Please note Fire Bricks will develop hairline cracks over time & only need to be replaced upon total disintegration of the brick, where you can see metal side of stove.
- Please note issues such as replacing fire rope, replacing the door handle, paint peeling, bricks cracking, replacing grate, glass or baffle doesn't warrant a service call & can be easily done using manual instructions

Terms of Warranty

This warranty is only valid if:

- The unit has been installed in accordance with the latest building regulations.
- The chimney which services the stove is in accordance with the latest building regulations.
- All installation instructions in the manual have been followed.
- The stove is operated as described in the manual.
- The stove is only used to burn fuel as described in the manual.
- Any stove installed must have a rain cap fitted to the top of the chimney.

This Warranty Does Not Cover:

- Damage resulting from the use of fuel not recommended in the manual. (e.g. over-firing)
- Where a crack appears on top of stove, resulting from a layers of pipework placed all the way to ceiling with no twin-wall adapter or joist support to carry the weight of these pipes.
- Parts which are damaged by external causes such as unadapted chimneys, thunderstorms. dampness., faulty plumbing, faulty fuel and mistreatment.
- Any nuts or bolts of handles that become loose due to use or mistreatment
- Body paint peeling / Enamel Cracking due to stove being over-fired
- Breakage of glass
- If the appliance is not serviced on a yearly basis according to instructions below.
- Damage created by surface rust. (this is caused by cleaning the stove with a wet cloth or water from the chimney)

Annual Service

Once a year service should be completed by a HETAS / METAC approved fitter. Service Checklist:

- 1) Door is sealed correctly. (You may need to change fire rope & also adjust locking nut on door handle.)
- 2) Remove all consumable parts - baffle, grate, fire retainer & bricks. Clean & Examine, replace if damaged.
- 3) Examine all paintwork. If paint has faded, stove may need to be repainted due to over-firing.
- 4) Ensure that chimney or flue system is installed & supported correctly & that all joints are sealed properly.

HENLEY STOVES TERMS & CONDITIONS

Replacement Parts

- If you are unsure where the stove was purchased, please visit our website www.henleystoves.com/stockists/ to find a list of your local stockist, or go to www.henleystovesparts.com and order your part online.

Maintenance

- Neglecting to regularly service your Henley Stove or maintain it to an acceptable standard IE if parts are clearly damaged, burnt out & not replaced.
- Failure to replace consumable parts in your stove will result in irreparable damage to stove & will invalidate your warranty

Boiler Stoves - Installation & Maintenance *ONLY APPLICABLE TO BOILER STOVES

- Henley Stoves advise that you consult with a heating specialist to determine the correct size & BTU's for your heating requirements, before you install a Boiler Stove.
- We strongly recommend that our stoves are plumbed independently. We do not advise you use a dual system which incorporates both oil & solid fuel, running at the same time. In our experience this system does not work.
- If you are experiencing an issue with the plumbing such as no hot water being pushed to the radiators or a low heat output to the room, Henley Stoves can only offer advice.
- Henley Stoves can recommend a name of an independent service engineer to determine if there is an issue with the stove or the plumbing.
- The service engineer will provide a detailed report outlining any issues (if any) at a cost to you for €450 (this fee may vary depending on location) which is prior to any inspection. Once a report is received from a qualified engineer, Henley Stoves will assess & make a decision based on the report's results.
- We strongly recommend only qualified HETAS / METAC approved plumber installers as unqualified installers will void your warranty.
- Failure to fit a rain-cap will cause water to come down chimney & pool on top of stove. This will cause severe corrosion & has in our experience been a leading cause in Boiler Stoves leaking.
- If we find the stove has been flued out the top with no rain cap fitted, the warranty is null & void.
- We also require proof of maintenance and/or detailed service record in order for warranty to be valid.
- Henley Stoves can only replace a Boiler stove found with a leak after it has been delivered to our warehouse for a forensic examination. After examining we will determine if the stove should be replaced or not.
- We will not cover any additional costs of plumbing or labour.

Insert Boiler Stoves *ONLY APPLICABLE TO BOILER STOVES

- Insert Boiler Stoves are primarily designed to heat water to radiators.
- In some cases if the stove is running too many radiators, the heat output can vary from 2kW to 5kW heat output to the room.
- We strongly recommend that a radiator is fitted in the room where the stove is installed, to maximize heat output to the room.

Downdraught (not covered under warranty)

- If you are experiencing an issue when refueling the stove, i.e. smoke spilling back into the room, in our experience this is caused by the stove being fitted in a bungalow or chimney stack is too low.
- You will need to contact a chimney specialist to rectify this problem. Henley Stoves can only offer advice.

Contacting Henley

The fastest way to help a customer who has an issue with one of our stoves, is to email service@henleystoves.com with the following:

- 1) Customer's full name & address & telephone number
- 2) Name of the shop where you purchased the stove
- 3) Name & telephone number of the person who fitted the stove.
- 4) Detailed photographs of issue with stove
- 5) Brief description of the problem in writing.

Once we receive this information, we will contact the customer to resolve the situation.

PRODUCT FICHE



Energy Labelling Directive - (EU) 2015/1186

Supplier / Manufacturer: : Henley Stoves

Model Name : Arklow Eco

Equivalent Model (s) :

Energy Efficiency Class : A

Direct Heat Output : 4.6 kW

Indirect Heat Output : 4.6 kW

Energy Efficiency Index : 107

Useful Energy Efficiency : 79.2 %

Specific Precautions :
Always follow the manufacturers instructions

Henley Stoves,
Curraheen, Tralee,
Co. Kerry, Ireland
www.henleystoves.com

HENLEY
STOVES